Masters Theses

Student Theses and Dissertations

Fall 2014

On temporal and frequency responses of smartphone accelerometers for explosives detection

Srinivas Chakravarthi Thandu

Follow this and additional works at: https://scholarsmine.mst.edu/masters_theses



Part of the [Computer Sciences Commons](#)

Department:

Recommended Citation

Thandu, Srinivas Chakravarthi, "On temporal and frequency responses of smartphone accelerometers for explosives detection" (2014). *Masters Theses*. 7345.

https://scholarsmine.mst.edu/masters_theses/7345

This thesis is brought to you by Scholars' Mine, a service of the Missouri S&T Library and Learning Resources. This work is protected by U. S. Copyright Law. Unauthorized use including reproduction for redistribution requires the permission of the copyright holder. For more information, please contact scholarsmine@mst.edu.

ON TEMPORAL AND FREQUENCY RESPONSES OF SMARTPHONE
ACCELEROMETERS FOR EXPLOSIVES DETECTION

by

SRINIVAS CHAKRAVARTHI THANDU

A THESIS

Presented to the Faculty of the Graduate School of the
MISSOURI UNIVERSITY OF SCIENCE AND TECHNOLOGY

In Partial Fulfillment of the Requirements for the Degree

MASTER OF SCIENCE IN COMPUTER SCIENCE

2014

Approved by

Dr. Sriram Chellappan, Advisor

Dr. Wei Jiang

Dr. Dan Lin

Copyright 2014

SRINIVAS CHAKRAVARTHI THANDU

All Rights Reserved

ABSTRACT

The increasing frequency of explosive disasters throughout the world in recent years have created a clear need for the systems to monitor for them continuously for better detection and to improve the post disaster rescue operations. Dedicated sensors deployed in the public places and their associated networks to monitor such explosive events are still inadequate and must be complemented for making the detection more pervasive and effective. Modern smart phones are a rich source of sensing because of the fact that they are equipped with wide range of sensors making these devices an appealing platform for pervasive computing applications. The processing capabilities of the smartphone are fairly good for its sensors to be used in building explosive detection systems on them which will make the existing systems more robust and sensing handy to the mobile users. This thesis presents various challenges and opportunities in utilizing the capabilities of the sensors in smartphone for building those systems.

Using inexpensive accelerometer sensors in the smartphone, a design of Smartphone based Seismometer for explosion detection is been proposed in this work. We have evaluated the design using the accelerometer raw-data collected by the smartphone from a real explosion blasted in a mining laboratory.

ACKNOWLEDGMENTS

I would like to express my gratitude to all those who have helped me during this research. Firstly, I would like to thank my advisor Dr. Sriram Chellappan for giving me the opportunity to work on this project, his valuable insights and suggestions have helped me to overcome many hurdles during this work. I am grateful to him for the advice and guidance he gave me throughout my Masters program. I also thank Dr. Chellappan for his moral support during my tough times by understanding and encouraging me to focus on my goals. Further, I thank the National Science Foundation for most of the funding during my Masters program. I would like to thank Dr. Wei Jiang and Dr. Dan Lin for being part of my thesis committee and taking time to review this work.

I would like to thank Professor Paul Worsey and the staff at Experimental Mining Laboratory at Missouri University of Science and Technology for their assistance in explosive data collection using smartphones. I would also like to thank GeoSonics/Vibra-Tech Inc. for providing raw data of seismometer which served as a ground truth for analyzing the capability of smartphone based Seismometer.

A special thanks to all my friends whose constant support and encouragement has always been crucial for me. Finally, I would like to dedicate this work to my parents (Krishna and Amrutha) and my sisters (Vasavi and Anitha) for their emotional support and unconditional love and sacrifices.

TABLE OF CONTENTS

	Page
ABSTRACT	iii
ACKNOWLEDGMENTS	iv
LIST OF ILLUSTRATIONS	vii
LIST OF TABLES	viii
 SECTION	
1 INTRODUCTION	1
1.1. MOTIVATION	3
1.2. ORGANIZATION OF THESIS	4
2 RELATED WORK	5
2.1. COMMUNITY SENSE AND RESPONSE (CSR) SYSTEM	5
2.2. I-SHAKE PROJECT	5
3 BACKGROUND	7
3.1. EXPLOSION EVENTS	7
3.1.1. Sources of Explosion	7
3.2. SEISMOMETER	8
3.2.1. Conventional Seismometer	8
3.2.2. Modern Seismometer	9
3.3. SMARTPHONE ACCELEROMETER	10
4 DESIGN OF A SMARTPHONE BASED SEISMOMETER	12

4.1. PROBLEM STATEMENT	12
4.2. DESIGN	13
4.2.1. Design of a Smartphone Based Application	13
4.2.2. Design of the Algorithm.....	13
5 EXPERIMENTAL EVALUATION.....	19
5.1. DESIGN IMPLEMENTATION.....	19
5.1.1. Implementation of Smartphone Application	19
5.1.2. Implementation of Algorithm.....	19
5.2. EXPERIMENTAL SETUP	21
5.3. DATA RESULTS AND ANALYSIS	22
5.3.1. Stabilization.....	22
5.3.2. Time Domain Analysis	24
5.3.3. Frequency Domain Analysis	26
6 CONCLUSION AND FUTURE WORK	30
BIBLIOGRAPHY.....	31
VITA	33

LIST OF ILLUSTRATIONS

Figure	Page
3.1 Conventional Seismometer With a spring attached to weight and pen for writing the relative motion of the earth on a rotating drum	8
3.2 Modern Seismometer with Geophone and Microphone	9
3.3 LIS344ALH - Accelerometer Sensor	10
4.1 Modes of the Smartphone while monitoring for the explosive events	15
4.2 The processing of the incoming accelerometer sample received	15
5.1 Depiction of the Experimental setup near the blast Site	21
5.2 Stabilization time achieved for various time windows	23
5.3 Stability of the Smartphone device during explosion	24
5.4 Time Domain representation of explosion event captured by Smartphone ..	25
5.5 Time Domain representation of explosion event captured by Seismometer..	26
5.6 Time Domain representation of both Smartphone and Seismometer events.	27
5.7 Correlation analysis of Smartphone and Seismometer detected events	27
5.8 Frequency Domain representation of explosion event captured by Seismometer	29
5.9 Frequency Domain representation of explosion event captured by Smartphone	29

LIST OF TABLES

Table	Page
5.1 Details of the Smartphone Devices used to collect accelerometer data during the explosive blasts.....	20
5.2 Details of the explosion at Experimental Mine	22

1. INTRODUCTION

In day-to-day life we experience innumerable ground vibrations around us. Such, vibrations range from those which cannot be felt by human to the vibrations that cause disasters leading to loss of property, also affecting the human body [1], these vibrations may occur due to a natural disaster or due to manmade events like explosion blasting, construction, demolition. If we have systems predicting the source of vibrations or localizing them, then these systems will assist greatly in the scenarios of rescue or cautioning the people well before these vibrations causing big damage to humans.

There is prior research in the areas of monitoring the earthquakes, windstorms and building their corresponding alarm systems [2], [3]. On the other hand, comparatively fewer studies have been found on monitoring explosive events. There is a need for systems for localizing and prediction of the explosives by continuous monitoring.

The excitation induced by earth quake produces seismic waves and these are different from the ground shock waves induced by the explosions [4]. Ground shock waves are a result of an explosion those propagate through the medium from the source of explosion and Seismic waves are waves of energy that travel through earths layers and are a result of an earthquake or a volcano that imparts low-frequency acoustic energy [5]. The spectral differences between the earth quake and quarry blast which is a form of an explosion were explored in recent times to a great extent forming a solid base for classifiers which will uniquely identify the explosions from all its counterparts [6], [7], [8]. The ground vibrations and seismic waves are measured by an instrument called Seismometer. The major sources of ground shocks are construction related explosions, accidental detonation of stored explosive, terrorist attacks and bombs. A

ground shock generated by an underground or a surface explosion propagates from the source to the measuring device.

Dedicated sensing devices may not serve the purpose of continuous monitoring due to their static nature and the possibility of the very device getting damaged during the disaster. On the other hand, modern-day smartphones are ubiquitously equipped with the accelerometer sensors and with a considerably good processing capability to analyze the accelerometer data sensed by the phone, this motivated us to design a smartphone based seismometer for monitoring explosive events in the vicinity of the smartphone device. This makes sensing handy to the mobile users and serve the purpose of continuous monitoring and the detection may be made more effective due to the mobile nature of them and the undeniable fact that they are continuously connected over the network.

Our approach to build a Seismometer on a smartphone presents different challenges in using the capabilities of accelerometer sensors in smartphones. The primary challenge is to deal with the volume of the raw data that is sensed by the accelerometer over a continuous period, a smart phone accelerometer sensor reading the acceleration values at the fastest sampling rate which is 200 samples per second could maintain a history of its observations by logging them which produces 25 Gigabytes of raw data per month. This is a large volume of data to store and analyze, so with much less storage the detection of events is made possible by implementing triggering algorithms like the seismometers do [9]. However, the challenge is the computation of algorithm in real-time while the smartphone is continuously reading the accelerometer values at a high sampling rate (mentioned earlier) for fine grain detection of weak motion events whose probability of detection is very low by the sensing devices. Most of the Seismometers use simple average or threshold based triggering approach for detection, some of the other approaches use adaptive technique, neural network methods or sophisticated ones based on pattern recognition [10].

An effective scheme for real-time seismic data recording systems is still a challenging task because all the processes must be completed within one sample period otherwise the incoming sample information might be lost. For the mobile devices, to run these algorithms in a given sampling period might become difficult because of the limited processing capabilities. In the design proposed for a smartphone based seismometer, we have used a trigger based approach for the detection of the explosive events that adapts standard average comparison with a predefined threshold. The averaging process is simple to compute and takes less time, making it suitable for computing devices with light weight processing capabilities and for on-line seismic applications [9]. In this thesis, smartphone is shown capable of detecting the explosive event from the continuous very large accelerometer data-set. The detected event is evaluated by comparing its temporal and frequency responses with that of the Seismometer that is installed at the explosion blast site at Experimental Mine, Missouri University of Science and Technology. The false triggers and the intensity measurements are out of scope of this thesis.

1.1. MOTIVATION

Modern smart phones are ubiquitously equipped with accelerometer, pressure and microphone sensors, the presence of these sensor-rich-smartphones is most likely in the scenarios of explosion. The sensing capabilities of the smartphone may become a rich source of detection during disastrous scenarios, this helps the smartphone owners to plan the evacuation better and also helps the rescue finders localize the source, detect the status of victims to speed up the rescue services. The time lapse between the explosions and the arrival of rescue teams is so precious and become crucial for saving a victim, so the detection capabilities of the smartphone if better utilized can help detecting the source of the explosions leading to the effective rescue

scenario. This motivates us to study the capability of smartphone to turn into a monitoring device during explosions, demolitions of building etc that cause ground vibrations. To evaluate the capabilities of the smartphone, the vibration scenario's can be replicated in the laboratory using testing procedures like "Shake table" [3].

The goal of this thesis is to study the capability of the smartphone to detect the explosive events, so we have chosen to evaluate the capabilities of the phone with a real explosive data. Vibration monitoring is performed every day in the mining and construction industries [11] using commercial seismic recorders that are equipped with geophones, accelerometers, and microphones. This motivated us to evaluate the capabilities of the smartphone using real data-sets collected from the explosions in mining and other ground vibration causing activities.

1.2. ORGANIZATION OF THESIS

The rest of the thesis is organized as follows. In Section 2, Related work is discussed. Further, Section 3 details the background of the Seismometer. In Section 4, a design proposed for Smartphone Based Seismometer is presented. Further 5 presents a detailed description of the Experimental Evaluation and Section 6 concludes the work.

2. RELATED WORK

In the last decade research is seen in the area of monitoring the ground vibrations using the inexpensive accelerometers equipped in the smartphones. They have built a seismic network for the smartphone users to contribute the significant event data to a centralized server.

2.1. COMMUNITY SENSE AND RESPONSE (CSR) SYSTEM

Community Sense and Response (CSR) system proposed by Faulkner et al [2] leverages accelerometer sensors in smartphones and consumer electronics for monitoring earthquakes. This system gather, share and act on sensory data from peoples internet enabled devices equipped with the sensors. In this research, the author described about the algorithmic challenges of designing, building and evaluating a scalable network for real-time awareness of dangerous earthquakes. This work shares similarity with ours in making the phone a ground vibration detector; however the focus was monitoring the earthquakes on a community scale.

2.2. I-SHAKE PROJECT

The iShake project designed by Jack et al [3] at the University of California, Berkeley introduced a mobile client-backend server architecture that uses sensor-equipped mobile devices to measure earthquake ground shaking. iShake provides general public with a service to more easily contribute a quantitatively significant data to earthquake research by automating the data collection and reporting mechanisms via the iShake mobile application. They have designed a client application for collecting accelerometer readings from a steady smartphone device which pervasively

collects the data. The design we have proposed inspires from this work to some extent, while the system proposed by them monitors vibrations caused by earthquake like the former system discussed (CSR System).

This thesis work shares similarity with the above discussed systems in the aspect of working with the accelerometer sensors in smartphones, however the focus was on monitoring the earthquakes producing ground vibrations and on sharing the data across the network. Our work differs from them in the sense of detecting explosive events by the smartphones by analyzing the continuously sensed accelerometer data. The data is collected initially from the smartphone accelerometer and further analyzed with a design algorithm proposed to detect the explosive event. In addition to dealing with the capability of smartphones to detect these events by proposing a Seismometer design, this thesis have also shown the evaluation of the design by comparing it with the ground truth data-set collected from a Seismometer installed at the Explosive site for the same explosive blast in the experiment.

There exists a test procedure called Shake-table devised to verify the quality of the accelerometer recordings in the context of earthquake which is simulated in the laboratory by the testing system. The former systems proposed uses this experimental setup for the evaluation of the system while this thesis deals with the data collected at the real explosive laboratory at Missouri University of Science and Technology.

3. BACKGROUND

This Section focuses on the background of the Explosive events, further the measurement devices and the Accelerometers used in the smartphone.

3.1. EXPLOSION EVENTS

An explosion is defined as an event that results in a rapid increase in volume and release of energy in an extreme manner. Explosions can be caused by cataclysmic event like a volcanic eruptions or man made explosions like nuclear, chemical or bomb blasts [12]. The effects caused by all sorts of explosions discussed are fairly same, the outcomes of the explosions are blast waves which result in the ground vibrations generating high pressures in the near atmosphere. A blast wave is defined as the pressure and flow resulting from the deposition of a large amount of energy in a small very localized volume [13]. High explosives, which detonate, generate blast waves. The monitoring of these vibrations and measuring of these blast waves is done by an instrument called Seismometer (discussed in Section 3.2).

3.1.1. Sources of Explosion. High-order explosives (HE) are more powerful than low-order explosives (LE). HE detonate to produce a defining supersonic over-pressurization shock wave. Several sources of HE include Trinitrotoluene, C-4, Semtex, nitroglycerin and ammonium nitrate fuel oil (ANFO). LE deflagrate to create a subsonic explosion and lack HE's over-pressurization wave. Sources of LE include pipe bombs, gunpowder, and most pure petroleum-based incendiary bombs such a Molotov cocktails or aircraft improvised a guided missiles. HE and LE induce different injury patterns. Only HE produce true blast waves.

3.2. SEISMOMETER

Seismometers are instruments that measure motions of the ground, including those of seismic waves generated by earthquakes, volcanic eruptions and other seismic sources. Records of seismic waves allow seismologists to map the interior of the earth, locate, and measure the size of these different sources[14] .

3.2.1. Conventional Seismometer. Conventional seismometer comprise of spring and weight and it works on the principle of inertia, the weight is sensitive to up-down motions of the earth as shown in Figure 3.1. The relative motion between the weight and the earth provides a measure of the vertical ground motion. If a recording system is installed such as a rotating drum with a paper attached to a frame and a pen attached to the weight, then this relative motion between the weight and earth can be recorded to produce a history of ground motion, called a seismogram [15].

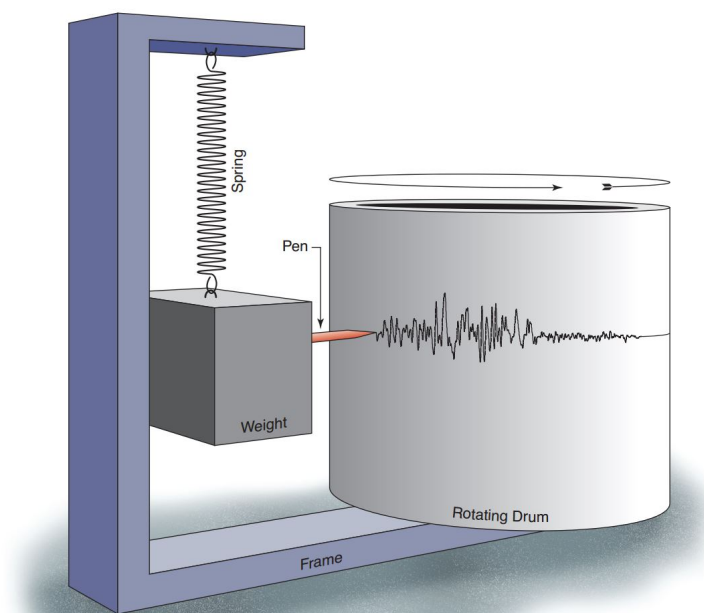

Figure 3.1. Conventional Seismometer With a spring attached to weight and pen for writing the relative motion of the earth on a rotating drum

3.2.2. Modern Seismometer. Modern Seismometers use electronic sensors, amplifiers, and recording devices that make a record of ground vibrations caused by an earthquake, explosion or other earth-shaking phenomenon. Seismic sensor is a part of seismometer that translates ground motion into electrical signal, which are processed and recorded by the instrument based on analog or digital circuits [9].



Figure 3.2. Modern Seismometer with Geophone and Microphone

The two important components contained in a modern seismometer are Geophone and Microphone as shown the Figure 3.2, the Geophone is to measure the voltage generated by the relative motion of the ground whereas microphone measures the acoustic response of the ground vibration. They use a tri-axial design, in which three identical motion sensors are set at the same angle to the vertical but 120 degrees apart on the horizontal. Vertical and horizontal motions can be computed from the outputs of the three sensors. Seismometers unavoidably introduce some distortion

into the signals they measure; later the signal measured is processed by data detection algorithms to trigger to an event. The selection of these triggering algorithms depends upon the processing capability of the seismometer to compute the algorithms in real-time.

3.3. SMARTPHONE ACCELEROMETER

The accelerometer sensors used in the smartphones are manufactured using MEMS technology (Micro-Electro-Mechanical) Systems making them miniaturized and powerful. The modern-day smartphone is equipped with low-power three-axis linear accelerometer which measures acceleration (in meters per $second^2$) in Linear, Transversal and Vertical directions. The accelerometer sensor includes sensing element and an IC interface able to take the information from the sensing element and provide the data samples to external world. The maximum sampling rate that a smartphone accelerometer could give is currently 200 samples per second. However it varies over various phone platforms, 100 samples per second is guaranteed in almost all the smartphones across the platforms.

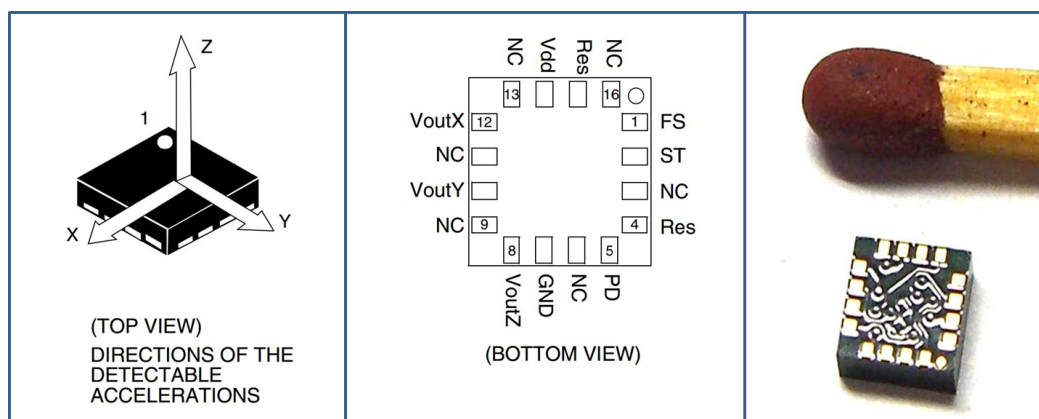

Figure 3.3. LIS344ALH - Accelerometer Sensor

Most of the modern smartphones comprise of the accelerometer sensor manufactured by ST Micro electronics and the state-of-the-art accelerometer model is LIS344ALH (shown in Figure 3.3). Sensitivity is essentially ratiometric to supply voltage that is increasing or decreasing the voltage supply will result in the increase or decrease linearly and the calibration level is $\pm 8\%$ [16]. The accelerometer reading outputted by the smartphone accelerometer should be calibrated to obtain the actual acceleration and the calibration depends on the sensitivity of the sensor.

Sensitivity describes the gain of the sensor and can be determined by applying 1g acceleration to it. The sensor can measure DC accelerations and the output value is measured by applying 1g acceleration to the sensor. This value changes very little over temperature and also very little over time. The Sensitivity tolerance describes the range of sensitivities of a large population of sensors.

4. DESIGN OF A SMARTPHONE BASED SEISMOMETER

In this section we discuss about the problem statement and then present a detailed design of the Smartphone based Seismometer

4.1. PROBLEM STATEMENT

This thesis work focusses on the problem of studying the capability of Smartphone accelerometer sensor to detect the explosive events. The smartphone could maintain an archive of all the accelerometer readings recorded at a sampling rate suitable for explosive event detection, but this results in enormous amount of data flooding smartphones memory. The main function is to detect the ground vibrations typical to explosions, by continuously analyzing the accelerometer readings. A triggering algorithm designed serves for the detection of typical explosive events by applying it on the continuous data recorded from the smartphone.

Triggering algorithm is designed in such a way that the incoming data is not stored continuously and permanently however the it still processes all incoming signals, this is the challenge in real-time, because all the processes must be completed within one sample period which means the algorithmic computations on a received sample must be completed by the time next sample arrives. With this challenge, we aim to build a design for processing the incoming signals in real-time using standard average based algorithm to effectively detect the explosive event from the Smartphones accelerometer data. We assume the smartphone to be stationary during the explosion to be capable of detecting the explosive events without any false event detection and the triggering process is not started until the confirmation of stabilization of the device.

4.2. DESIGN

A design is proposed to build a smartphone based Seismometer which collects and stores the continuous accelerometer readings. Further the data collected is processed to detect the explosive event from the data. The design has two stages in which the first stage focuses on the acceleration data collection using the smartphone accelerometer and the second stage analyses the data collected using the triggering algorithm designed. These are explained in detail in the following sections.

4.2.1. Design of a Smartphone Based Application. The design of the smartphone based application deals with the collection of accelerometer samples at the highest possible sampling rate for fine grain analysis to detect the explosion event. The modern day smartphone is equipped with the tri-axis accelerometer sensor that measures acceleration (in meters per second²) in Linear, Transversal and Vertical directions. The application runs in the background continuously and listen to the accelerometer changes in three directions, as soon as the application receives these readings from the sensor, it subsequently tags them with the time-stamp that acts as index. The time-stamp tagged accelerometer samples forms a record and is stored to the memory of the smartphone for post-analysis.

4.2.2. Design of the Algorithm. The design proposed deals with the post-analysis of the stored data samples outputted by the tri-axial accelerometer sensor of the smartphone. The data analysis of the incoming signal by the algorithm does not start until it receives the confirmation that the device is stable, since we aim to detect the explosive events by a stationary smartphone device, otherwise a noisy event may get detected. To manage these issues a three-state design is proposed , Figure 4.1 shows the overview of the design of the post-analysis of the data. This design intends to be implemented across the platforms, making it feasible to adapt to all the smartphones equipped with accelerometer sensor. The seismometer design uses a

simple threshold based algorithm for detection of events and a condition called Voting Scheme parameter specifies whether or not the device moves to the event detection mode from triggering mode. Voting scheme parameter for our design is set as *'if any two out of three channels triggers, then the device moves to the event detection mode'*. The algorithm design is set by the following basic parameters:

- Sampling rate of the sensor (S)
- Stabilizing window duration (T_s)
- Stabilization Threshold (S_D)
- Size of Buffer in seconds (b)
- trigger threshold level (TR_{th})
- dettrigger threshold level (DTR_{th})
- Trigger filters (T_f)
- Pre-event memory (T_{PEM})
- Post-event time (T_{PET})
- Voting schemes (V_{num})

The Stored raw-data samples which were read by the accelerometer sensor of the smartphone are analyzed by processing algorithm as shown in the Figure 4.2, the samples are fed to the algorithm for every sampling period as recorded by the smartphone. The processing of this sample should be completed in one sample period before the next sample arrives for processing. While the signal is processed, the device undergoes various states and those states are explained in detail as following:

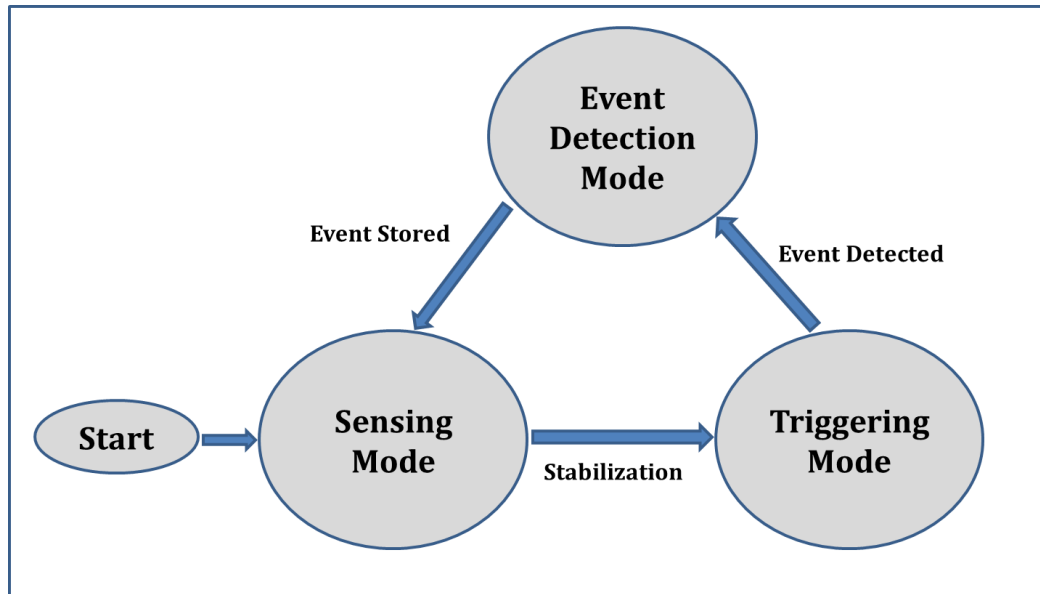

Figure 4.1. Modes of the Smartphone while monitoring for the explosive events

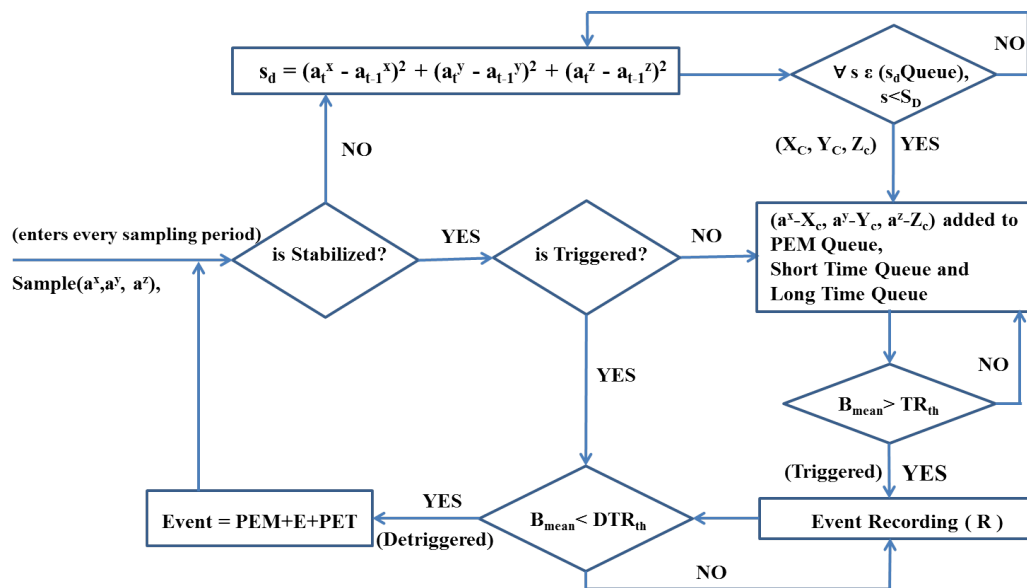

Figure 4.2. The processing of the incoming accelerometer sample received

Sensing Mode: As soon as the smartphone starts monitoring, it has to be checked for the stability since the design specifically detects the explosive events from the stationary device. In this mode the stability of the device is made sure to move on to the next state and stability (s_d) of the system is determined by the change of acceleration from the last known sample to the present sample. Since the smartphone accelerometer is a tri-axial sensor that gives acceleration in longitudinal, transversal and vertical (x,y and z respectively) directions, the stability is determined for the resultant of acceleration in all the 3 directions. The resultant is calculated by the L2 norm of the difference of acceleration vector from its previous known to its current sample value as shown in Equation 4.1.

$$s_d = (a_t^x - a_{t-1}^x)^2 + (a_t^y - a_{t-1}^y)^2 + (a_t^z - a_{t-1}^z)^2 \quad (4.1)$$

where t is time of arrival of current sample, t-1 is time of arrival of previous sample and $a_t = (a_t^x, a_t^y, a_t^z)$. A moving time window T_s seconds is selected for stability stability to make sure that the device is stable for T_s Seconds and the s_d value is computed for each incoming sample and stored in a queue(in first-in-first-out fashion) for maintaining a moving window of samples, and the size of queue is taken as $T_s * S$ (where S is the sampling rate of the accelerometer Sensor). In addition to the s_d value computation, the acceleration values a_t^x, a_t^y, a_t^z are maintained in three separate queues of size $T_s * S$ to determine stabilization Correction values after the device is stabilized. All the s_d values in the queue are checked against a preset stability S_D with a condition as shown in Equation 4.2

$$\forall s \in (s_d \text{ queue}), s < S_D \quad (4.2)$$

This condition is checked for every sample arrived until the Condition in the Equation 4.2 satisfies and if the condition is satisfied then the device is declared to

be stable (for a continuous T_s seconds time window) and the device moves to the next state, otherwise it remains in the sensing mode, in this mode no triggering of the event is declared due to lack of stability. Just before moving to the next state, average stable values of a_t^x, a_t^y, a_t^z contained in their respective queues are computed as X_c, Y_c, Z_c which will be used as correction factors for the incoming values in the Triggering Mode. Ideally $s_d = 0$, if the device is absolutely stable, this happens when $a_t^x = a_{t-1}^x$, so we try to minimize the S_D value to attain the maximum stabilization.

Triggering Mode: In this mode the algorithm processes each incoming signal in 3 different steps as explained below, when an accelerometer sample is received for 3 orientations that is for x, y and z directions, then they are processed in separate channels undergoing the steps mentioned below:

Step-1: The acceleration samples in x,y and z directions are received and then are corrected as $(x - X_c), (y - Y_c), and (z - Z_c)$ in their respective channels using the respective correction factors evaluated in the previous state. Then the sample is copied in a Buffer Queue (B) and Pre-Event memory Queue of sizes $(b*S) and (PEM*S)$ respectively. Once the size of the maximum queue is filled, then Steps 2 and 3 are evaluated, otherwise only step-1 is applied for the future samples until the maximum queue is filled.

Step-2: The average mean for B (buffer) queue is calculated as B_{mean}

Step-3: Then B_{mean} value is checked against the Trigger condition shown in Equation 4.3.

$$B_{mean} \geq TR_{th} \quad (4.3)$$

If the condition in equation 4.3 is satisfied for an individual channel, then that channel is declared to be triggered and the recording is started only after the device as a whole triggers which is determined by the Voting Scheme condition (as discussed

earlier in this section), otherwise remains in the triggering mode re-doing steps 1, 2 and 3 for the samples sensed further.

Event Detection Mode: The device after triggering enters this mode fetches the last stored PEM queue(from previous mode) in to an array of size (PEM * S). If the device is in Event detection mode already, then the incoming samples directly enter this mode bypassing the former two modes as shown in Figure 4.2 and the records these samples in the Event array 'E' of dynamic size since the event length is not pre-known. The Event is recorded until the condition in the Equation 4.4 is satisfied to declare a dettrigger state.

$$B_{mean} \leq DTR_{th} \quad (4.4)$$

After the device detriggers, it records the event into the array of size Post-Event time (PET) pre-set by the user and after this array is filled then the event detection is completed. Then a Detected Event with a pre and post traces is prepared as shown in Equation 4.5 and is stored in the smartphone device locally, further the device moves back to the Sensing mode.

$$Event = PEM + E + PET \quad (4.5)$$

Where PEM = Pre-Event memory ; E = Event array ; PET = Post-Event Array

The computation of the algorithm for an incoming sample which is a combination of computation for 3 channels dedicated for acceleration values in x, y, and z directions within the sampling interval is evaluated in the experimental analysis.

5. EXPERIMENTAL EVALUATION

In this Section we first describe about the design implementation of the Seismometer, further a detailed discussion of experimental setup is described and finally a detailed analysis of the results concludes the section.

5.1. DESIGN IMPLEMENTATION

The design proposed in Section 4.2 is implemented in two modules, the first module as the data collection module using a smartphone application for collecting Accelerometer data and the second one as post-analysis of the collected data, these are explained in detail in the following sections.

5.1.1. Implementation of Smartphone Application. We have implemented smartphone based application on Android platform to collect the accelerometer data with a specified sampling rate suiting the explosive frequencies ranging from 30-50Hz, the details of the smartphone are shown in Table 5.1. The accelerometer sensor measures the Acceleration (meters per second²) in Linear, Transversal and Vertical directions(x, y and z respectively). As soon as the application receives the readings from sensors, it tags the values with the time-stamp information (in milliseconds precision) and subsequently writes each time-stamp tagged sample as a record to a Comma Separated Value(.csv) file. The output file is stored in the SD card of the smartphone device in the form of raw data, later used for analysis which is further discussed in the Section 5.3.

5.1.2. Implementation of Algorithm. The data collected will be analyzed using the algorithmic design proposed as in 4.2.2 and the design was implemented on the JAVA platform. Implementing design on JAVA leverages the advantage of

Table 5.1. Details of the Smartphone Devices used to collect accelerometer data during the explosive blasts

SMARTPHONE MODEL	Samsung Galaxy S4
MODEL NUMBER	SAMSUNG-SGH-I337
OPERATING SYSTEM	Android-4.4(KitKat)
SAMPLING RATE	100 samples per Second

implementation of algorithm in android platform since it is built on JAVA background, this eases the deployment of algorithm on the JAVA based smartphone platforms in the future work. The algorithm is designed in such a way that it allows us to preset the parameters required for the algorithm as shown in the following, and the algorithm will be run on the raw data-set collected from smartphone. Each data sample will be inputted to the algorithm for every sampling period that simulates the realtime processing of the accelerometer sample. After the processing of all the incoming samples from the raw data is completed, the result is generated which contains the detected events from the data-set analyzed.

- Sampling rate of the sensor S
- Stabilizing window duration T_s
- Stabilization Threshold S_D
- Size of Buffer in seconds - b
- trigger threshold level TR_{th}
- dettrigger threshold level DTR_{th}
- Pre-event memory (PEM) T_{PEM}
- Post-event time (PET) T_{PET}
- Voting schemes V_{num}

5.2. EXPERIMENTAL SETUP

For the experimental evaluation of the design, the data-set of Smartphones acceleration must be collected from an explosion to determine its capability of detection in real-time, and further the sensor data must be validated using a ground truth data-set. The challenge is to simulate the explosion environment for the experiment and also to get ground truth raw data, as a workout to this challenge we initially performed an experiment at Experimental Mine, Missouri University of Science and Technology to collect the raw accelerometer data samples from an underground mine during a ramp shot blast.

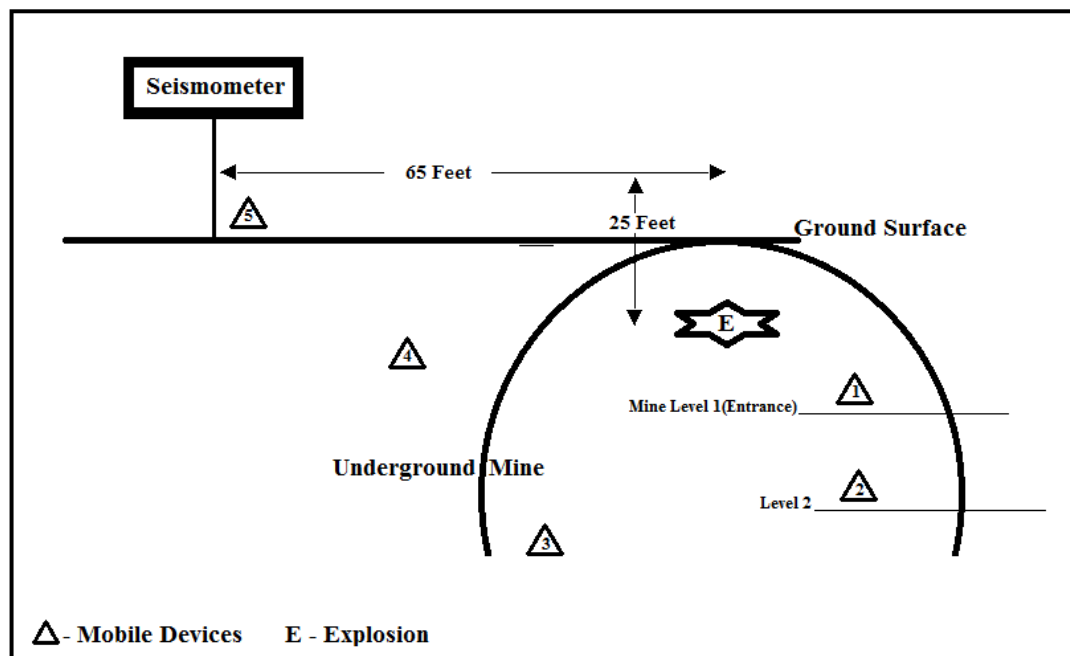

Figure 5.1. Depiction of the Experimental setup near the blast Site

The underground mine is about 25 feet beneath the ground level and 65 feet distant from the point where Seismometer is installed as shown in Figure 5.1, the explosive material is kept in the holes drilled to the ceiling of the mine and details of

the explosion for which the data is been collected is given in Table 5.2. The application described in Section 5.1.1 was installed and launched in 4 smart phones (see Table 5.1 for details) and were placed at various distances from the Explosion point at the blasting site and the seismometer is installed on the ground level as shown in the Figure 5.1. The nearest distance of the smartphone from Explosion is 10 Feet and farthest being 70 Feet, the Seismograph is installed statically mounted on to the rock and it runs continuously looking for the explosive event, when there is a blast occurred then the Seismometer triggers and sends out the detected event report to the server. We have collected the raw data of the triggered event from the seismometer and used it as ground truth data to evaluate the detected event from the smart phone using the proposed design.

Table 5.2. Details of the explosion at Experimental Mine

TYPE OF EXPLOSIVE	Dynamite (Unimax-TT)
MATERIAL BLASTED	Dolomite Lime
NO OF HOLES	15
EXPLOSIVE STICKS	15 Sticks (2 Charge)
CHARGE WEIGHT	7-15 pounds
DETONATING CORD	25-50 grains/foot

5.3. DATA RESULTS AND ANALYSIS

The raw data was collected using the smartphones placed at various distances as shown in Figure 5.1 from the blasting point, we have chosen to analyze the accelerometer data from the smartphone which is kept exactly beside the seismometer. Using the algorithm implemented in Section 5.1.2, the raw data collected from the experiment is analysed. We present the results in following Sections.

5.3.1. Stabilization. Initially before processing the samples for the triggering of the event, the Stabilization for the device is verified using the condition(from Equation 4.1):

$$s_d = (a_t^x - a_{t-1}^x)^2 + (a_t^y - a_{t-1}^y)^2 + (a_t^z - a_{t-1}^z)^2$$

For the device to be stable, the s_d will be ideally '0' if the device is absolutely stable, so the S_D must be chosen to be the lowest possible to make the device more stable satisfying the condition(from Equation 4.2):

$$s_d \leq S_D$$

If the stabilization values calculated for all the samples in the moving stabilization time window satisfies the condition in Equation 4.2, then the device is declared to be stable. For our data analysis we have chosen Stabilization Threshold (S_D) = 0.01 and Stabilization time window (T_s) = 1 Second.

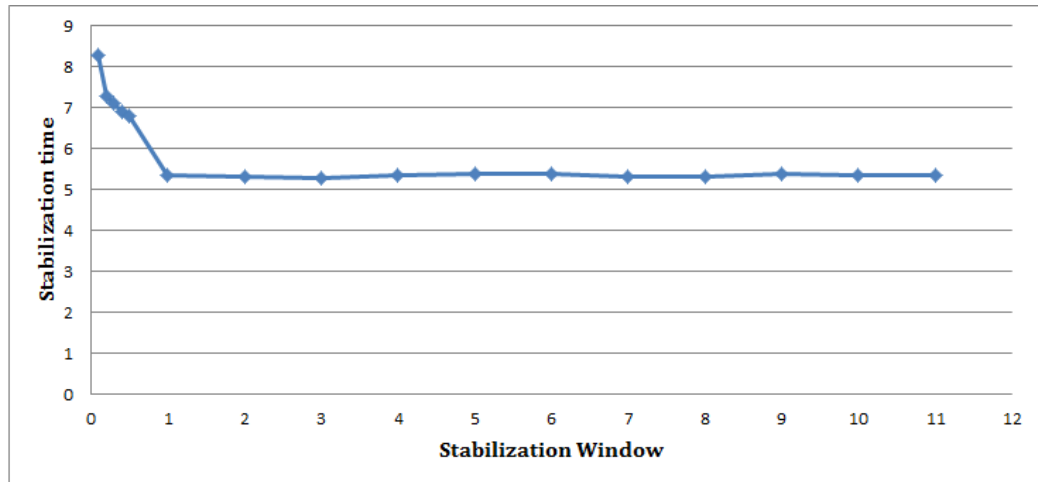

Figure 5.2. Stabilization time achieved for various time windows

The selection of a 1 second time window is determined from the experimental analysis explained in Figure 5.2 and found to be the minimum time window that can be selected to achieve a best stabilization time. This can be observed in Figure 5.2, stabilization time of 5.36 seconds is achieved after any time-window greater than 1

second, with these chosen values we have got the device stabilized in 5.73 seconds as shown in Figure 5.3 and then moved to trigger state. After the device is stabilized, the data is processed using algorithm designed as in Section 4.2.2. The (B_{mean}) for Buffer of size 'b' is evaluated for each channel separately at sampling period for a moving time window equals to the size of the Buffer (b), in our experiment we have chosen the time window of 5 Seconds. The (B_{mean}) was observed to show the signature of the detection for event detected time determined from the report generated by the Seismometer. We have evaluated the design by choosing various combinations for Trigger threshold (TR_{th}) to compare the (B_{mean}) calculated every sampling period, and could detect the event. The detected event from the algorithm was observed to be synchronous to the event detected by the Seismometer when verified with the time-stamp tag.

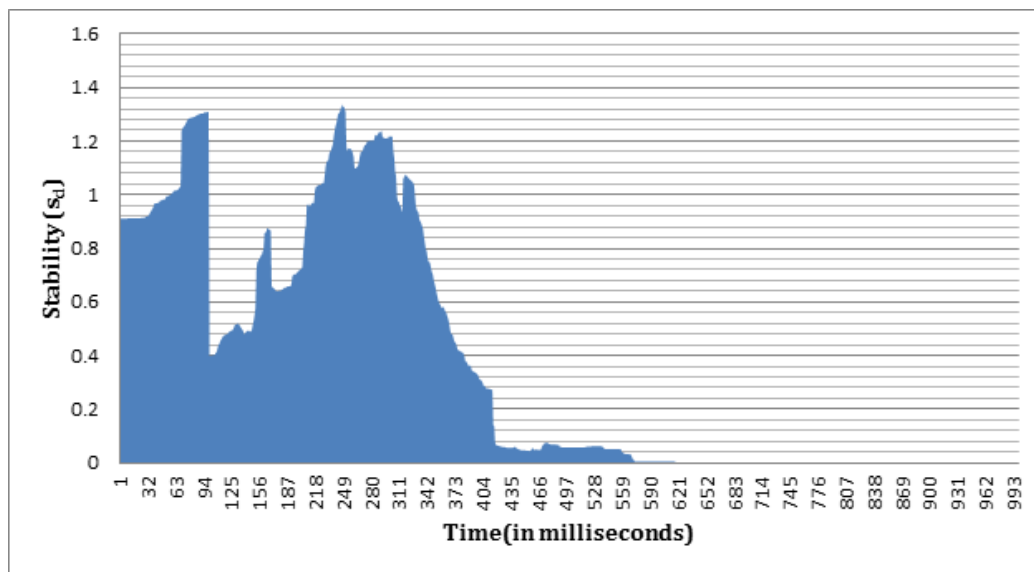

Figure 5.3. Stability of the Smartphone device during explosion

5.3.2. Time Domain Analysis. The algorithm was run for the complete raw data set and the results were shown to be encouraging by the detection of explosion blasts similar to that of the Seismometer. The time domain representation

of the explosive event detected by the Smartphone and Seismometer were shown in the Figures 5.4 and 5.5 respectively, in these plots X-axis represents event time of 6 seconds and Y-Axis represents amplitude of acceleration caused by ground vibrations (in meters per second²).

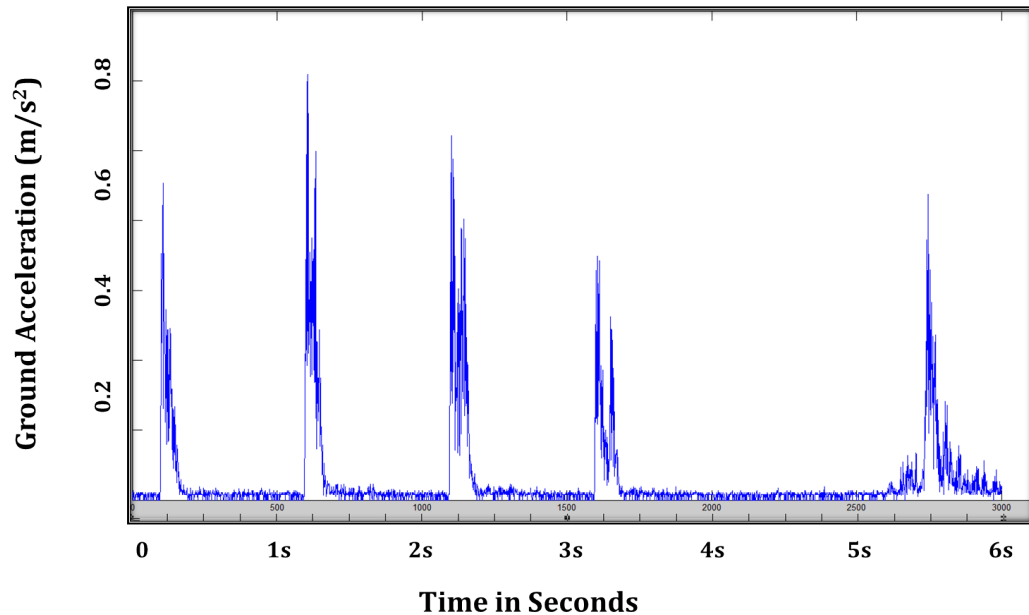

Figure 5.4. Time Domain representation of explosion event captured by Smartphone

From the events detected by Smartphone and Seismometer shown in Figures 5.4 and 5.5 respectively, it can be seen that the event of explosion captured by Seismometer and Phone sensors have got similarity in trends with respect to time domain. Also the amplitude is seen scaled down in the smartphone acceleration values recorded which can be seen in the Figure 5.6, this can be fixed by calibrating the smartphone to match the intensity shown by the Seismometer, but this requires a detailed analysis of intensity measurements which is out of scope of this work. In addition to this, the efficiency of detection is determined by the false-positive and false-negative triggering of the smartphone devices to the explosive events, which is also not in the scope of

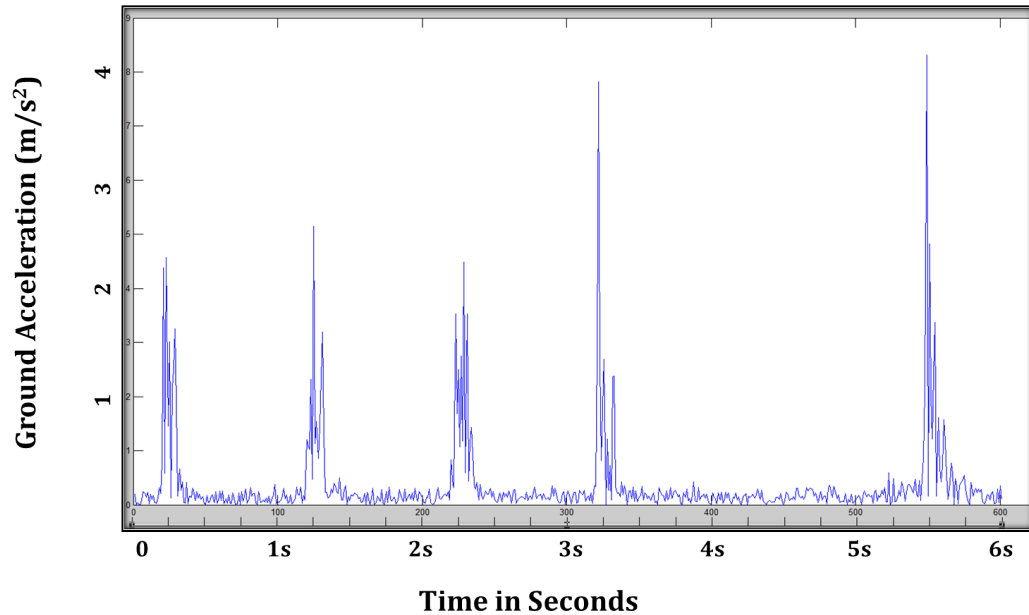

Figure 5.5. Time Domain representation of explosion event captured by Seismometer

this work.

To analyse more on the similarity of the trends, a correlation analysis was done to verify the goodness, we have used standard Pearson coefficient to do the correlation analysis and it is shown in the Figure 5.7 and the figure has plots of correlation and correlation with a rolling mean of 20 samples. From the figure it can be seen that the correlation shows the signature of detection and also the correlation is high during the occurrence of event spike. During the noise the correlation is observed to be least significant, however the correlation for all the spikes in the time domain was seen to be more than 0.75. This signifies that 75% of the time, the smartphones detection was found to be similar to that of the Seismometer.

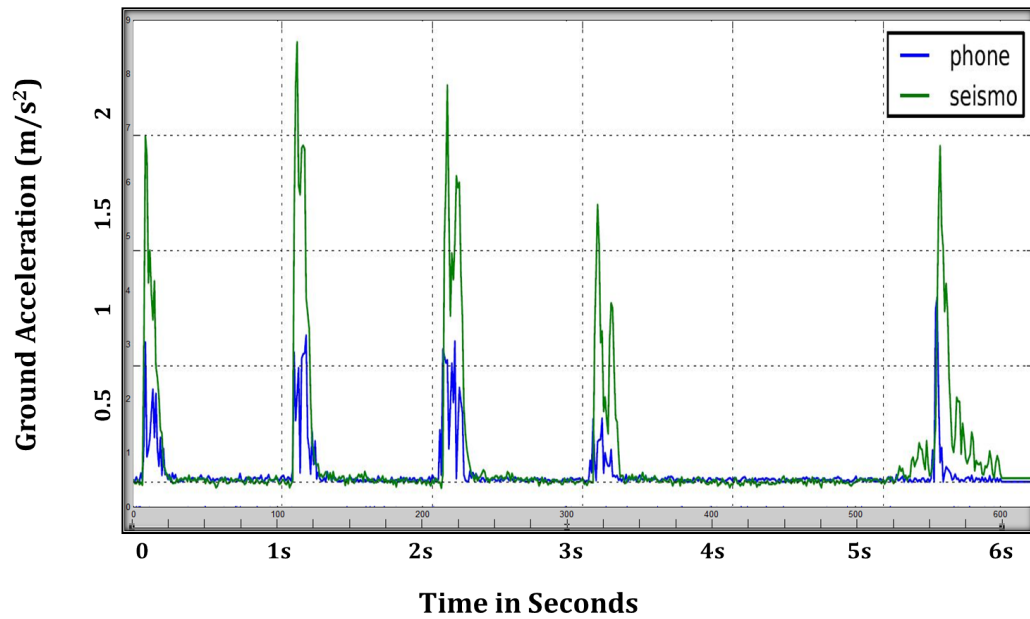

Figure 5.6. Time Domain representation of both Smartphone and Seismometer events

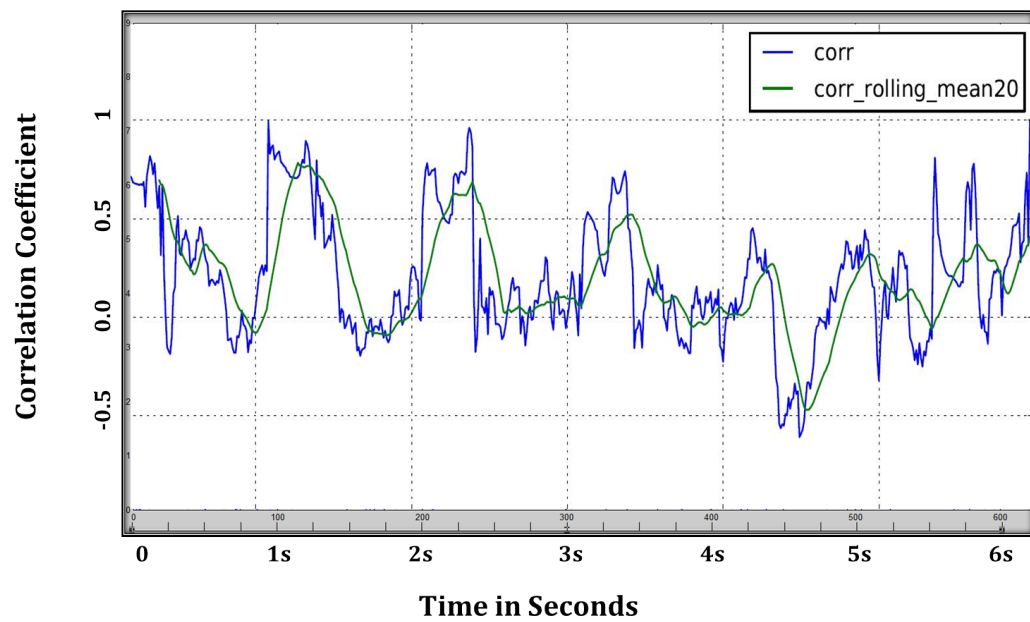

Figure 5.7. Correlation analysis of Smartphone and Seismometer detected events

5.3.3. Frequency Domain Analysis. Frequency domain analysis is also done to determine the spectral capability of the smartphones to determine the significant frequency component of the explosions similar to that of seismometer. Time domain data is converted to frequency domain to compare the data from a different perspective. It can be seen that Seismometer measures the peak amplitude at 83Hz frequency as seen in Figure 5.8, on the other hand mobile phone also measures it around 75-80 Hz as seen in Figure 5.9. A Similarity is observed in the frequency domain with a nominal difference, which can be overcome by a calibrating the device which requires expert analysis of intensity measurements. The frequency analysis has shown a satisfactory result in identifying a similar trend of dominant frequency pattern compared to that of Seismometer. However, mobile phone data when compared to that of the Seismometer, the presence of noise is observed significantly in the data, this is because the fine grain data not had been collected from the smartphones during the blast without any frequency filter implemented in the design proposed, which if implemented may be limited by the computational capability of the smartphone.

The parameters set for the algorithm designed and the results evaluated may correspond to the explosive blasts specific to mining. They can be generalized if we have more data-sets collected for different intensities of the blast. In the experiments we have collected accelerometer recordings by the smartphones deployed at various distances from the blast and by analyzing them we have observed a mere variation B_{mean} when compared from the nearest phone to the blast to the farthest, this input when fused with the intensity variations in the smartphone may become a consistent baseline to build a distance model to localize the explosive blasts.

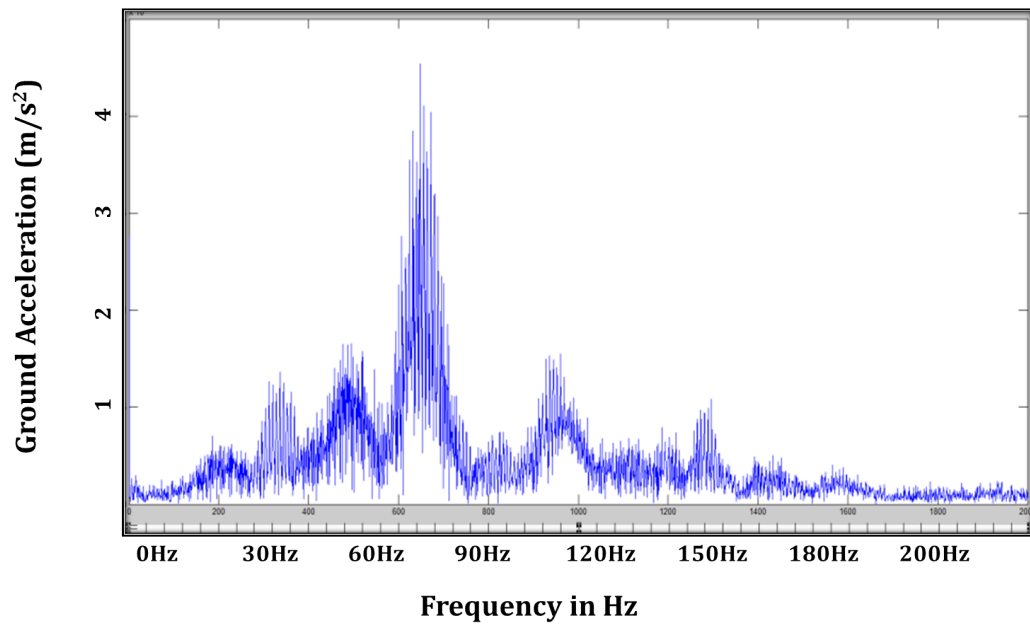

Figure 5.8. Frequency Domain representation of explosion event captured by Seismometer

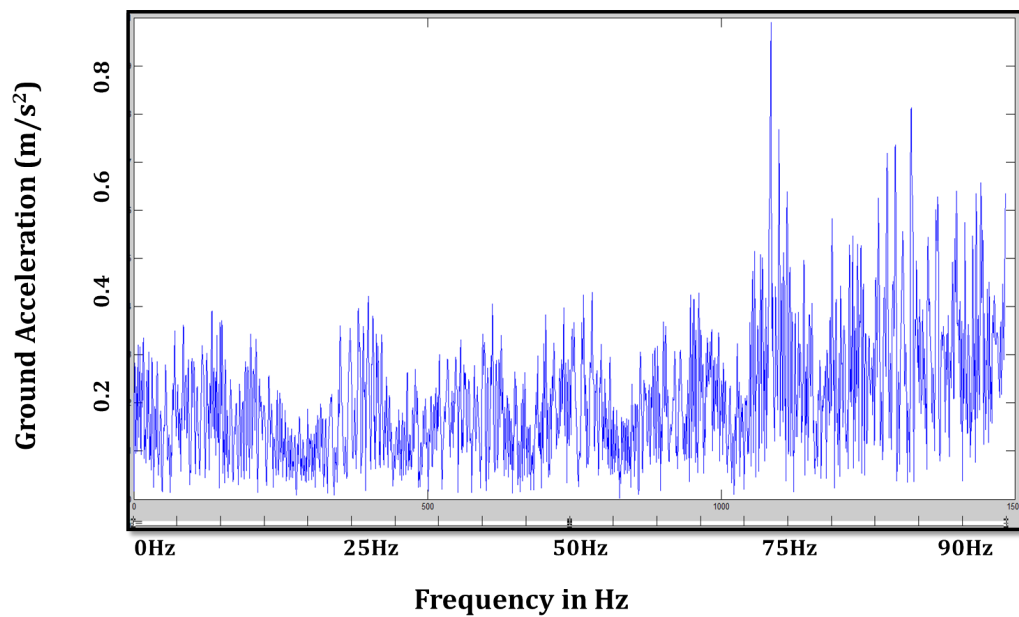

Figure 5.9. Frequency Domain representation of explosion event captured by Smartphone

6. CONCLUSION AND FUTURE WORK

The data-sets collected from the smartphone accelerometers using the application built on it are reliable to be efficient for the detection of explosive event by processing the data using the algorithm design. The design proposed for smartphone based seismometer shows the capability of triggering to the strong motion explosive blasts. By allowing the user to set the parameters based on the blast site conditions, triggering to the typical explosion events was shown possible. The evaluations of frequency and the time-domain responses of the detected events were encouraging and demonstrated the smartphone capable of responding to the explosions by showing the signatures of the explosive events.

Future works of the project include implementation of the processing algorithm in the smartphone that results in the device triggering to the explosive event in real time by using its processing capabilities. Further, testing the design for false triggers in the real-time and measuring the intensity parameters thus evaluating the nature of the blast using the results generated from the smartphone, also implementing the design in other mobile platforms to evaluate the efficiency of the design across the smartphone platforms.

BIBLIOGRAPHY

- [1] R. Karl Zipf and Kenneth L. Cashdollar. Effects of blast pressure on structures and the human body. Technical report, Department of Defense data from Glasstone and Dolan, Explosions and Refuge Chambers, 2001.
- [2] Matthew Faulkner, Robert Clayton, Thomas Heaton, K. Mani Chandy, Monica Kohler, Julian Bunn, Richard Guy, Annie Liu, Michael Olson, MingHei Cheng, and Andreas Krause. Community sense and response systems: Your phone as quake detector. *Commun. ACM*, 57(7):66–75, July 2014.
- [3] Jack Reilly, Shideh Dashti, Mari Ervasti, Jonathan D. Bray, Steven D. Glaser, and Alexandre M. Bayen. Mobile phones as seismologic sensors: Automating data extraction for the ishake system. *IEEE T. Automation Science and Engineering*, 10(2):242–251, 2013.
- [4] R. P. Dhakal. Explosion induced structural response: An overview. In *Rotorua: New Zealand Society of Earthquake Engineering Annual Conference, 2004 NZSEE Conference on*, pages 1–8, March 2004.
- [5] Seismic Wave. http://en.wikipedia.org/wiki/Seismic_wave, 2014. [Online; Accessed, October 21 2014].
- [6] ElHassanAit Laasri, Es-Sad Akhouayri, Dris Agliz, and Abderrahman Atmani. Seismic signal discrimination between earthquakes and quarry blasts using fuzzy logic approach. In Abderrahim Elmoataz, Driss Mammass, Olivier Lezoray, Fathallah Nouboud, and Driss Aboutajdine, editors, *Image and Signal Processing*, volume 7340 of *Lecture Notes in Computer Science*, pages 166–174. Springer Berlin Heidelberg, 2012.
- [7] B. R. Allmann, P. A. Shearer, and E. Hauksson. Spectral discrimination between quarry blasts and earthquakes in southern california. *Bulletin of the Seismological Society of America*, 98(4):2073–2079, Aug 2008. n/a.
- [8] Eray Yldrm, Ali Glba, Gndz Horasan, and Emrah Doan. Discrimination of quarry blasts and earthquakes in the vicinity of istanbul using soft computing techniques. *Computers and Geosciences*, 37(9):1209 – 1217, 2011.
- [9] B.K. Sharma, Amod Kumar, and V.M. Murthy. Evaluation of seismic events detection algorithms. *Journal of the Geological Society of India*, 75(3):533–538, 2010.

- [10] Amadej Trnkoczy. Understanding and parameter setting of STA/LTA trigger algorithm. Technical report, Department of Electrical Engineering, University of Ljubljana, Slovenia, 1999.
- [11] Construction Vibration Monitoring. <http://www.src.com.au/construction-vibration-monitoring/>, 2014. [Online; Accessed, October 21 2014].
- [12] Explosion. <http://en.wikipedia.org/wiki/Explosion>, 2014. [Online; Accessed, October 21 2014].
- [13] Blast Wave. http://en.wikipedia.org/wiki/Blast_wave, 2014. [Online; Accessed, October 21 2014].
- [14] Seismometer. <http://en.wikipedia.org/wiki/Seismometer>, 2014. [Online; Accessed, October 21 2014].
- [15] How Does a Seimometer Work? http://www.iris.edu/hq/files/publications/brochures_onepagers/doc/OnePager7.pdf.
- [16] LIS344ALH MEMS Accelerometer Sensor. <http://www.st.com/st-web-ui/static/active/en/resource/technical/document/datasheet/CD00182781.pdf>, 2014. [Online; Accessed, October 21 2014].

VITA

Srinivas Chakravarthi, Thandu earned his Bachelors degree in Electronics and Communication Engineering from Jawaharlal Nehru Technological University, India in 2010. After completion of his bachelors, he worked as a Systems Engineer at Infosys Technologies Limited, Hyderabad, India for 2 Years(till December 2012). He has been a graduate student in the Computer Science Department at Missouri University of Science and Technology since January 2013 and worked as a Graduate Research assistant under Dr. Sriram Chellappan from June 2013 to till date. He received his Masters in Computer Science at Missouri University of Science and Technology in December 2014.